



Flow control switch – normally open or normally closed contact

- Adjustable switching point
- Low pressure loss
- Reliable under difficult conditions
- For liquid

Product variants described in the data sheet may differ from the product presentation and description.

Type description

The flow control switch is suitable for liquids as normally open or normally closed contact. The switching process is triggered by a reed contact. The flow moves the magnet, which is located on a rocker bar. The switching point is adjustable. The flow control switch works reliably even under difficult conditions with low pressure drop. The switching process is well repeatable.

Table of contents

1. General technical data	3
2. Dimensions	3
3. Ordering information	4
3.1. Bürkert eShop – Easy ordering and quick delivery.....	4
3.2. Bürkert product filter.....	4
3.3. Ordering chart.....	4

1. General technical data

Note:

Other versions on request

Product properties	
Dimensions	Detailed information can be found in chapter "2. Dimensions" on page 3.
Material	
Body	Brass
Rocker bar	PPO (PPE/PA GFN3)
Repeatability	± 15 % (Switching point setting)
Nominal pressure	25 bar ^{1.)}
Operating temperature	Max. +110 °C
Electrical data	
Schaltstrom	Max. 1 A
Schaltleistung	26 VA at max. 230 V AC 20 W at max. 48 V DC
Approvals and certificates	
Protection class	IP65
Product connections	
Electrical connection	Cable plug DIN 43650 Form A

1.) Pressure data: Overpressure with respect to atmospheric pressure

2. Dimensions

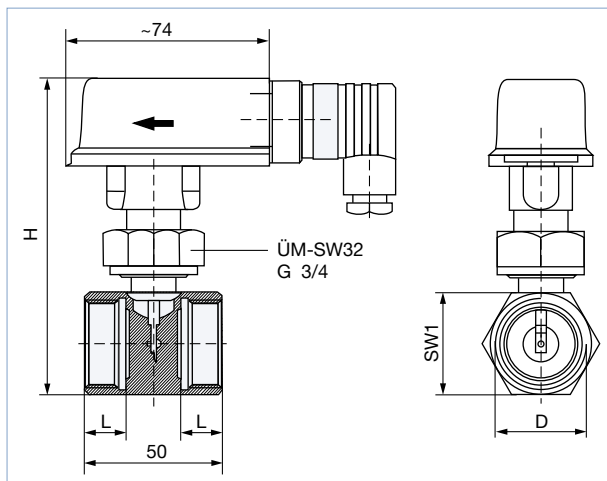

DN	D	SW1	L	H	Switching point range		Max. flow rate
					For ascending current	For decreasing current	
[mm]	[mm]	[mm]	[mm]	[mm]	[l/min]	[l/min]	[l/min]
8	G ¼	27	11	105	2.1...2.7	1.8...2.4	45
10	G ⅜	19	11	105	2.5...3.2	2.2...2.9	60
15	G ½	19	11	105	3.4...4.2	3.0...3.8	67
20	G ¾	27	15	110	7.0...9.1	6.4...8.2	120
25	G 1	32	15	119	13.5...17.0	12.0...15.5	195
32	G 1 ¼	41	15	126	15.5...20.5	14.5...19.0	240
40	G 1 ½	55	15	133	26.5...34.5	25.5...32.5	400
50	G 2	70	15	148	39.5...51.0	39.0...50.0	400

3. Ordering information

3.1. Bürkert eShop – Easy ordering and quick delivery



Bürkert eShop – Easy ordering and fast delivery

You want to find your desired Bürkert product or spare part quickly and order directly? Our online shop is available for you 24/7. Sign up and enjoy all the benefits.

[Order online now](#)

3.2. Bürkert product filter

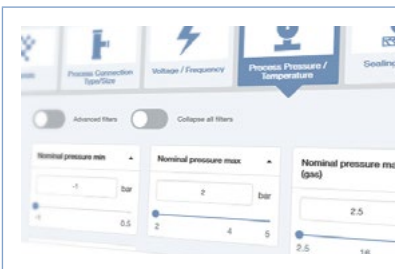









Bürkert product filter – Get quickly to the right product

You want to select products comfortably based on your technical requirements? Use the Bürkert product filter and find suitable articles for your application quickly and easily.

[Try out our product filter](#)

3.3. Ordering chart

DN [mm]	Article no.
G ¼	784322 
G ⅜	784323 
G ½	784324 
G ¾	784325 
G 1	784326 
G 1 ¼	784327 
G 1 ½	784328 
G 2	784329 

Bürkert – Close to You

For up-to-date addresses
please visit us at
www.burkert.com

DTS 1000364464 EN Version: B Status: RL (released | freigegeben | validé) printed: 17.06.2020

