



Flowmeter/Threshold detector with paddle wheel

- Indication, monitoring, transmitting and On/Off control in one device
- Freely adjustable outputs (transistor or relay)
- Automatic calibration using Teach-In
- Process value output: 4...20 mA
- Flow threshold detector

Product variants described in the data sheet may differ from the product presentation and description.

Can be combined with



Type 8792 ▶
Digital electropneumatic
Positioner SideControl



Type 2300 ▶
Pneumatically operated
2-way angle seat control
valve ELEMENT



Type 8644 ▶
AirLINE SP electropneu-
matic automation system

Type description

The paddle wheel device Type 8032 is designed for use in clear, neutral or aggressive liquids. The device is provided as flowmeter or threshold detector.

The device is made up of a compact Inline sensor-fitting with paddle wheel (Type S030) and a transmitter with display (Type SE32). The device is quickly and easily assembled thanks to a bayonet mounting and locking system. The Bürkert "Inline quarter-turn" technology ensures a leakage-free operation.

The Bürkert designed sensor-fitting system ensures simple installation of the devices into all pipelines from DN 06...DN 65.

The device is available with freely configurable switching outputs (transistor or relay) or with 4...20 mA process value output. The switching outputs enable the direct switching of valves and the establishment of a simple On/Off control circuit within a monitoring system. The switching points can be configured with the 3 keys directly at the display.

Table of contents

1. General technical data	3
2. Approvals and conformities	6
2.1. General notes.....	6
2.2. Conformity	6
2.3. Standards.....	6
2.4. Pressure Equipment Directive (PED).....	6
Device used on a pipe	6
2.5. North America (USA/Canada)	6
3. Materials	7
3.1. Bürkert resistApp	7
3.2. Material specifications	7
4. Dimensions	8
4.1. Transmitter SE32	8
With cable plug (DIN EN 175301-803)	8
With Cable plug (DIN EN 175301-803) and free positionable 5-pin M12 male connector	8
With cable plug (DIN EN 175301-803) and 8-pin M12 male connector.....	9
4.2. Transmitter Type SE32 mounted in an Inline sensor-fitting Type S030.....	9
5. Performance specifications	10
5.1. Pressure temperature diagram.....	10
6. Product installation	10
6.1. Installation notes	10
7. Product operation	11
7.1. Measuring principle.....	11
7.2. Functional overview	11
7.3. Function modes	12
Flow threshold detector with standard On/Off output	12
Flow transmitter with current output for the measurement value	12
8. Product design and assembly	13
8.1. Product assembly	13
9. Networking and combination with other Bürkert products	13
10. Ordering information	14
10.1. Bürkert eShop	14
10.2. Recommendation regarding product selection.....	14
10.3. Bürkert product filter.....	14
10.4. Ordering chart	14
Threshold detector Type SE32	14
Transmitter Type SE32	15
10.5. Ordering chart accessories	15

DTS 1000011084 EN Version: X Status: RL (released | freigegeben | validé) printed: 15.12.2023

1. General technical data

Note:

If the device is mounted in a humid environment or outside, then the maximum voltage allowed is **35 V DC** instead of 36 V DC.

Product properties

Material

Make sure the device materials are compatible with the fluid you are using.

Further information can be found in chapter [“3.1. Bürkert resistApp” on page 7.](#)

Further information on the materials can be found in chapter [“3.2. Material specifications” on page 7.](#)

Non wetted parts

Front panel film	Polyester
Cover	PC, glass fibre reinforced
Housing	PC, glass fibre reinforced
Screw	Stainless steel
Bayonet system	PC
Female cable plug/male fixed plug	<ul style="list-style-type: none"> • Body, contact holders and cable gland in PA • Cable gland seal and flat seal in NBR
Fixed connector	PA or PA and CuZn, nickel-plated

Wetted parts

Sensor armature	Brass, stainless steel, PVC, PP or PVDF (depending on the Inline sensor-fitting variant Type S030)
Axis and bearing	Ceramics (Al ₂ O ₃)
Paddle wheel	PVDF
Sensor-fitting body	Brass, stainless steel, PVC, PP or PVDF (depending on the Inline sensor-fitting variant Type S030)
Seal	FKM or EPDM (depending on the Inline sensor-fitting variant Type S030)
Display	8-digit LCD with backlighting
Compatibility	Any pipe from DN 06...DN 65 which are fitted with Bürkert Type S030 Inline sensor-fitting. For the selection of the nominal diameter of the Inline sensor-fittings, see data sheet Type S030 ▶.
Pipe diameter	DN 06...DN 65.
Dimensions	Further information can be found in chapter “4. Dimensions” on page 8
Measuring principle	Paddle wheel
Measuring range	<ul style="list-style-type: none"> • Flow rate: 0.5...1000 l/min (0.13...265 gpm) • Flow velocity: 0.3...10 m/s

Performance data

Measurement deviation	<ul style="list-style-type: none"> • Teach-In: $\pm 1\%$ of the measured value¹⁾ (at Teach-In flow rate value) • Standard K-factor: $\pm 3\%$ of the measured value¹⁾
Linearity	$\pm 0.5\%$ of full scale ¹⁾
Repeatability	$\pm 0.4\%$ of the measured value ¹⁾
4...20 mA output uncertainty	$\pm 0.5\%$ of current range
Operating mode	Threshold: window or hysteresis

Electrical data

Operating voltage	12...36 V DC $\pm 10\%$, filtered and regulated Connection to main supply: permanent (through external SELV (Safety Extra Low Voltage) and LPS (Limited Power Source) power supply)
Power source (not supplied)	Limited power source according to UL/EN 62368-1 standards or limited energy circuit according to UL/EN 61010-1 §9.4
Protection against DC polarity reversal	Yes
Current consumption	≤ 80 mA (no load)

Output	<ul style="list-style-type: none"> • Transistor <ul style="list-style-type: none"> – NPN and/or PNP, open collector – 700 mA max. (500 mA max. per transistor if both transistor outputs are wired) – frequency: 0...300 Hz – operation and thresholds can be parametered – NPN-output: 0.2...36 V DC – PNP-output: power supply – protection against short circuits • Relay <ul style="list-style-type: none"> – operation and thresholds can be parametered – non UL device: <ul style="list-style-type: none"> – single relay output: 250 V AC/3 A or 30 V DC/3 A – relay output and 4...20 mA current output: 48 V AC/3 A or 30 V DC/3 A – UL device: 30 V AC/42 V_{peak}/3 A or 60 V DC/1 A • Process value <ul style="list-style-type: none"> – 4...20 mA, galvanic insulation – loop impedance max.: 1300 Ω at 36 V DC, 1000 Ω at 30 V DC, 700 Ω at 24 V DC, 450 Ω at 18 V DC, 200 Ω at 12 V DC – response time (10...90 %): 3 s with filter 2 (default setting)
Voltage supply cable	<p>Max. 100 m length, shielded</p> <ul style="list-style-type: none"> • For female cable plug (supplied): <ul style="list-style-type: none"> – external diameter of wire: 6...7 mm – cross section of wires: 0.25...1.5 mm² • For 5-pin M12 female connector (not supplied): <ul style="list-style-type: none"> – external diameter of wire: 3...6.5 mm – cross section of wires: max. 0.75 mm² • For 8-pin M12 female connector (not supplied): <ul style="list-style-type: none"> – external diameter of wire: 5.9 mm – cross section of wires: 0.25 mm²
Medium data	
Fluid temperature	<p>With Inline sensor-fitting Type S030 in:</p> <ul style="list-style-type: none"> • PVC: 0...+50 °C (+32...+122 °F) • PP: 0...+80 °C (+32...+176 °F) • PVDF, stainless steel or brass: -15...+100 °C (+5...+212 °F) <p>See data sheet Type S030 ▶ for more information.</p>
Fluid pressure	<p>With Inline sensor-fitting Type S030 in:</p> <ul style="list-style-type: none"> • plastic: max. PN 10 • metal: max. PN 16 (PN 40 on request) <p>See data sheet Type S030 ▶ for more information.</p>
Viscosity	300 cSt max.
Rate of solid particles	Max. 1 %
Maximum particle size	0.5 mm
Process/Pipe connection & communication	
Pipe connection	<p>With Inline sensor-fitting Type S030 in:</p> <ul style="list-style-type: none"> • Plastic: true union with nut and solvent/fusion socket, spigot or external thread • Metal: internal or external thread, weld ends, clamp or flange <p>See data sheet Type S030 ▶ for more information.</p>
Electrical connection	<ul style="list-style-type: none"> • Cable plug according to DIN EN 175301-803, free positionable 5-pin M12 male connector or 8-pin M12 male connector
Approvals and conformities	
Directives	
CE directive	Further information on the CE Directive can be found in chapter “2.3. Standards” on page 6.
Pressure equipment directive	Complying with article 4, paragraph 1 of 2014/68/EU directive Further information on the pressure equipment directive can be found in chapter “2.4. Pressure Equipment Directive (PED)” on page 6.

North America (USA/Canada)	UL Recognized for the USA and Canada
Environment and installation	
Ambient temperature	Operation and storage: - 10...+60 °C (+ 14...+ 140 °F)
Relative air humidity	≤ 80 %, without condensation
Height above sea level	Max. 2000 m
Operating condition	Continuous
Equipment mobility	Fixed
Application range	Indoor and outdoor Protect the device against electromagnetic interference, ultraviolet rays and, when installed outdoors, against the effects of climatic conditions.
Degree of protection ²⁾ according to IEC/EN 60529	IP65 with the following conditions met: <ul style="list-style-type: none"> • device wired • connectors mounted and tightened or sealed
Installation category	Category I according to UL/EN 61010-1
Pollution degree	Degree 2 according to UL/EN 61010-1

1.) Under reference conditions i.e. measuring fluid = water, ambient and water temperature = 20 °C (68 °F), while maintaining the minimum inlet and outlet distances and the appropriate internal diameters of the pipes.

2.) Not evaluated by UL

2. Approvals and conformities

2.1. General notes

- The approvals and conformities listed below must be stated when making enquiries. This is the only way to ensure that the product complies with all required specifications.
- Not all available variants of the device can be supplied with the below mentioned approvals or conformities.

2.2. Conformity

In accordance with the Declaration of Conformity, the product is compliant with the EU Directives.

2.3. Standards

The applied standards which are used to demonstrate compliance with the EU Directives are listed in the EU-Type Examination Certificate and/or the EU Declaration of Conformity.

2.4. Pressure Equipment Directive (PED)

The device conforms to article 4, paragraph 1 of the Pressure Equipment Directive (PED) 2014/68/EU under the following conditions:

Device used on a pipe

Note:

- The data in the table is independent of the chemical compatibility of the material and the fluid.
- PS = maximum admissible pressure (in bar), DN = nominal diameter of the pipe

Type of fluid	Conditions
Fluid group 1, article 4, paragraph 1.c.i	DN ≤ 25
Fluid group 2, article 4, paragraph 1.c.i	DN ≤ 32 or PS*DN ≤ 1000
Fluid group 1, article 4, paragraph 1.c.ii	DN ≤ 25 or PS*DN ≤ 2000
Fluid group 2, article 4, paragraph 1.c.ii	DN ≤ 200 or PS ≤ 10 or PS*DN ≤ 5000

2.5. North America (USA/Canada)

Approval	Description
	<p>Optional: UL Recognized for the USA and Canada The products are UL Recognized for the USA and Canada according to:</p> <ul style="list-style-type: none"> • UL 61010-1 • CAN/CSA-C22.2 No. 61010-1

3. Materials

3.1. Bürkert resistApp

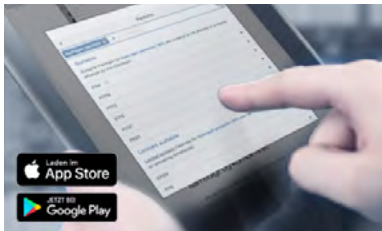

Bürkert resistApp – Chemical resistance chart

You want to ensure the reliability and durability of the materials in your individual application case? Verify your combination of media and materials on our website or in our resistApp.

[Start chemical resistance check](#)

3.2. Material specifications

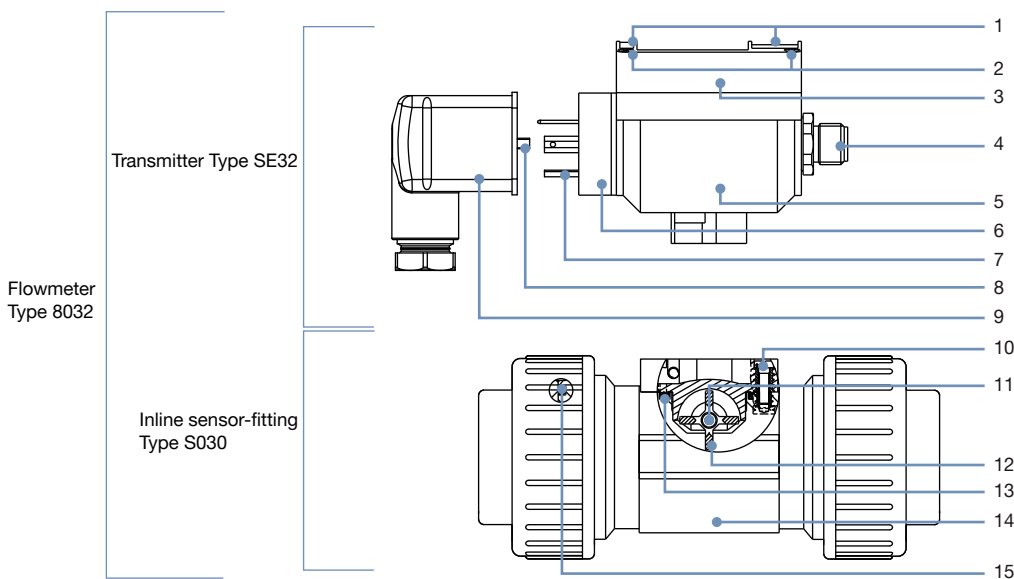

No.	Description	Material
1	Front panel folio	Polyester
2	Screws	Stainless steel
3	Cover	PC, glass fibre reinforced
4	M12 male connector	PA (5-pin), PA and CuZn nickel-plated (8-pin)
5	Housing	PC, glass fibre reinforced
6	Male cable plug (DIN EN 175301-803)	PA
7	Electrical contact	Sn
8	Screw	Stainless steel
9	Female cable plug (DIN EN 175301-803)	<ul style="list-style-type: none"> Body, contact holder and cable gland in PA Cable gland seal and flat seal in NBR
10	Screws	Stainless steel
11	Axis and bearings	Ceramics (Al ₂ O ₃)
12	Paddle wheel	PVDF
13	Seal	FKM or EPDM (depending on the Inline sensor-fitting variant Type S030)
14	Sensor-fitting body	Stainless steel (316L - 1.4404), brass (CuZn ₃₉ Pb ₂), PVC, PP, PVDF (depending on the Inline sensor-fitting variant Type S030)
15	Seals	FKM or EPDM (depending on the Inline sensor-fitting variant Type S030 and only for true union connection with nut and solvent/fusion socket)

DTS 1000011084 EN Version: X Status: RL (released | freigegeben | valide) printed: 15.12.2023

4. Dimensions

4.1. Transmitter SE32

With cable plug (DIN EN 175301-803)

Note:

Dimensions in mm, unless otherwise stated

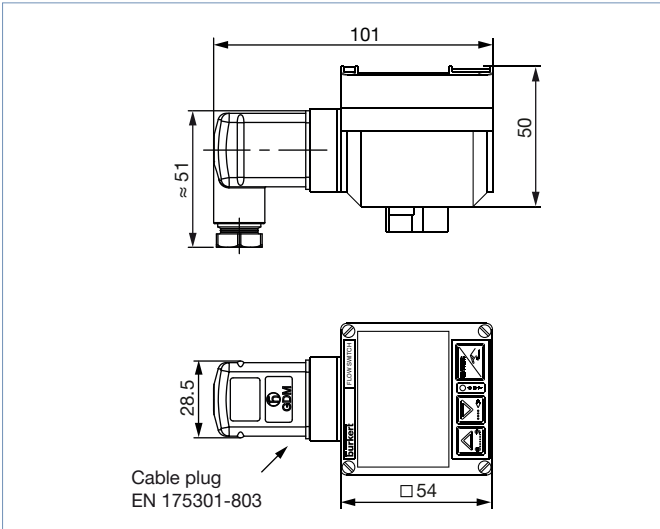

With Cable plug (DIN EN 175301-803) and free positionable 5-pin M12 male connector

Note:

Dimensions in mm, unless otherwise stated

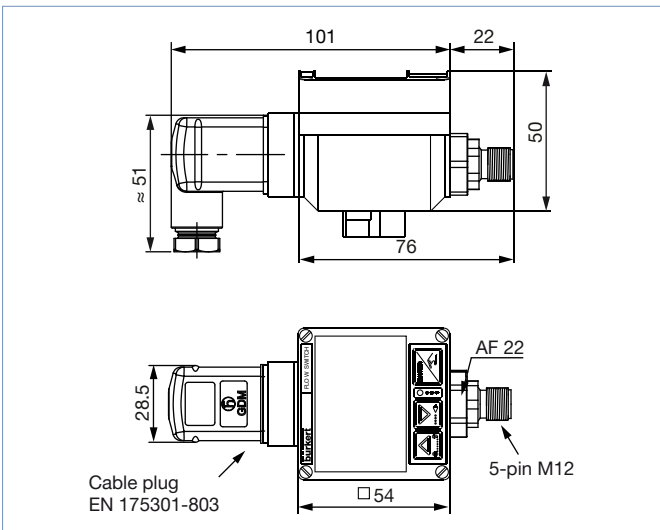

With cable plug (DIN EN 175301-803) and 8-pin M12 male connector

Note:

Dimensions in mm, unless otherwise stated

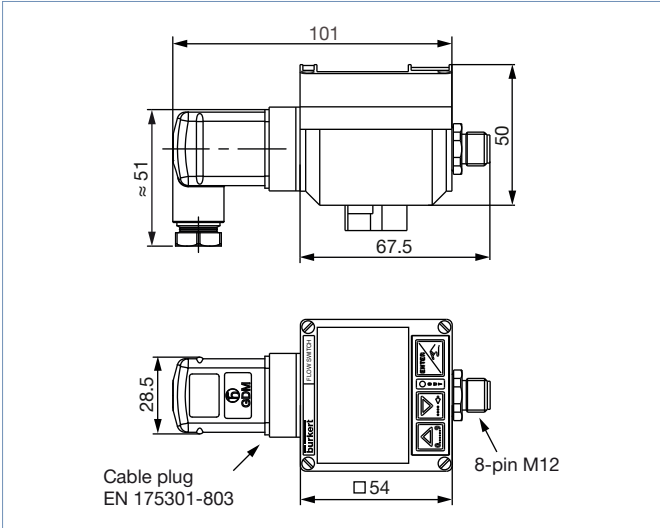

4.2. Transmitter Type SE32 mounted in an Inline sensor-fitting Type S030

Note:

Dimensions in mm, unless otherwise stated

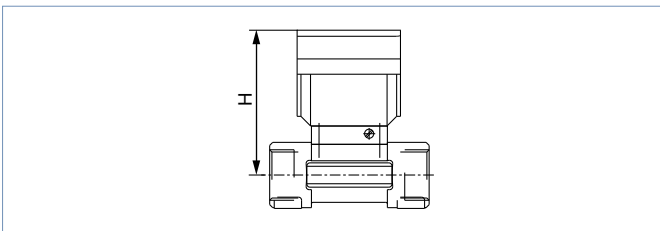

DN	H
06	79.5
08	79.5
15	84.5
20	82.0
25	82.2
32	85.8
40	89.6
50	95.7
65	95.7

5. Performance specifications

5.1. Pressure temperature diagram

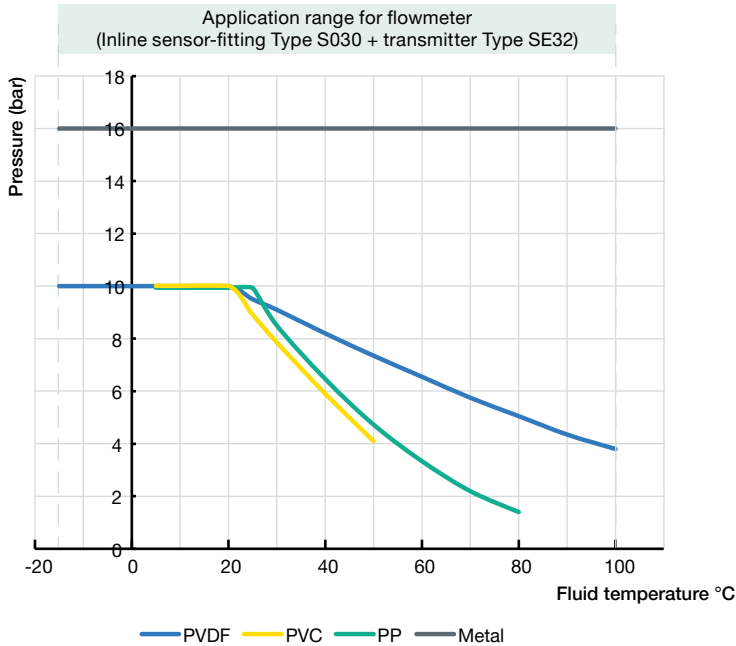

6. Product installation

6.1. Installation notes

Note:

The device is not suitable for use in gaseous media and steam.

Minimum straight distances upstream and downstream of the sensor must be observed. These stabilizing distances depend on the pipe's design. Increasing these distances or installing a flow conditioner may be necessary to obtain the best accuracy. For more information, refer to EN ISO 5167-1.

EN ISO 5167-1 specifies the straight inlet and outlet distances that must be complied with when installing fittings in pipe lines in order to achieve calm flow conditions. The most commonly used elements that could lead to turbulence in the flow are shown below. The related minimum inlet and outlet distances that ensure a calm flow are also specified.

Make sure that the measuring conditions at the point of measurement are calm and problem-free.

DN = Orifice

Fluid direction ⇨

Regulating valve^{1.)}

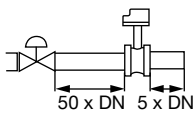

2 x 90° elbow joint

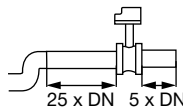

Expansion^{2.)}

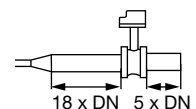

2 x 90° elbow joint
3 dimensional

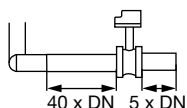

90° elbow joint
or T-piece

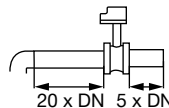

Reduction

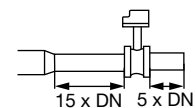

1.) If the valve cannot be mounted after the measuring device, the minimal distances have to be respected.

2.) If an expansion cannot be avoided, the minimal distances have to be respected.

Please note minimum flow velocity

The device can be installed in either horizontal or vertical pipes, but following additional conditions should be respected:

- The pipe always has to be filled with fluid at all times near the device.
- The pipe design must be such that no air bubbles or cavitation can form within the medium near the device at any time.

The flowmeter can be installed into either horizontal or vertical pipes.

Important criteria for this are; ensure that the measurement pipe is fully filled and that the measurement pipe is air bubble free.

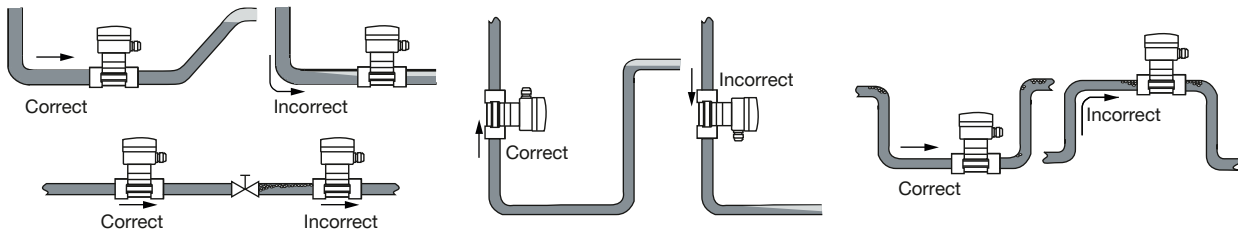

Pressure and temperature ratings must be respected according to the selected fitting material. The suitable pipe size is selected using the diagram in the chapter “Nominal size selection” of the **data sheet Type S030** ▶.

7. Product operation

7.1. Measuring principle

When liquid flows through the pipe, the paddle wheel with 4 inserted magnets is set in rotation, producing a measuring signal in the sensor (Hall sensor). The frequency modulated induced voltage is proportional to the flow velocity of the fluid.

A K factor, specific to each pipe, enables the conversion of this frequency into a flow rate.

This K factor is available in the Inline sensor-fittings’ operating instructions, see **Type S030** ▶.

The electrical connection is provided via a cable plug according to DIN EN 175301-803 and/or a M12 multipin plug.

7.2. Functional overview

The display is used to:

- read the value of certain parameters such as the measured flow rate
- parameterize the device by means of 3 keys
- read the configuration of the device
- get notification of some events.

Display and operating keys	No.	Description
	1	Shows if the relay is open or closed
	2	Means that the access to the parameters and test menus is protected through a code
	3	Bar graph is running in each mode, except during a Teach-In procedure
	4	“Confirm” key: <ul style="list-style-type: none"> • to confirm the function displayed • to confirm the parameters set
	5	Shows the status of the on/off output (red LED)
	6	“Next” key: <ul style="list-style-type: none"> • to select the digit at the left • to go to the next function
	7	“Back” key: <ul style="list-style-type: none"> • to change the value (0...9) of the selected digit • to go back to the previous function

DTS 1000011084 EN Version: X Status: RL (released | freigegeben | validé) printed: 15.12.2023

The device can be calibrated by means of the K-factor (conversion coefficient), or via the Teach-In function. User adjustments, such as engineering units, output, filter, bargraph are carried out on site.

The device has 2 operating levels:

- the process level
- the configuration level, which comprises the parameters and the test menus

Operating level	Functions
Process	<ul style="list-style-type: none"> • Indication of <ul style="list-style-type: none"> – the value of the measured flow rate – switching thresholds (high and low value) – the value of the 4...20 mA output (flowmeter only) • Access to the parameters and test menus of the configuration level
Configuration - parameters menu	<ul style="list-style-type: none"> • To make the settings needed for operation: <ul style="list-style-type: none"> – engineering units (international measuring units) – K-factor/Teach-In function – 4...20-mA-current output (flowmeter only) – selection of switching mode: window, hysteresis (see chapter “7.3. Function modes” on page 12) – selection of threshold value (see chapter “7.3. Function modes” on page 12) – delay – filter – 10-segment bargraph (select min. and max. value) • Additional parameter definition <ul style="list-style-type: none"> – backlighting – password protects the access to the parameters and test menus
Configuration - test menu	<ul style="list-style-type: none"> • To test the configuration made in the parameters menu with entering of a theoretical value • To read the frequency of the measured signal • To adjust the 4...20 mA current output

7.3. Function modes

Flow threshold detector with standard On/Off output

- 2 switching modes for the output, either hysteresis or window, inverted or not

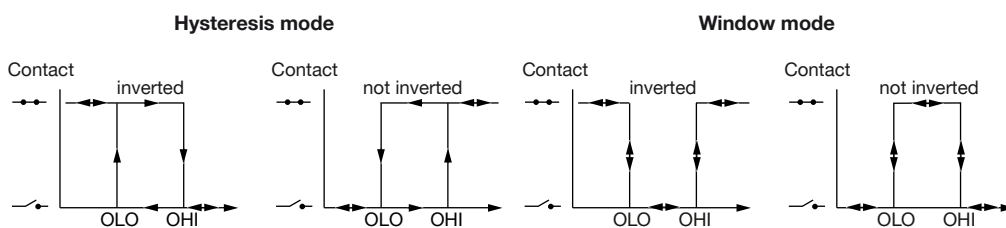

- Configurable delay before switching
- Possible outputs depending on the variant: relay, transistor NPN, transistor PNP

Flow transmitter with current output for the measurement value

- 4...20 mA output
- 4...20 mA output + relay output

DTS 1000011084 EN Version: X Status: RL (released | freigegeben | valide) printed: 15.12.2023

8. Product design and assembly

8.1. Product assembly

Note:

- The device Type 8032 is made up of a Bürkert Inline sensor-fitting Type S030 equipped with a paddle wheel sensor and a transmitter Type SE32.
- The Inline sensor-fitting Type S030 ensures simple installation into pipes from DN 06...DN 65. The transmitter Type SE32 can be mounted on any Inline sensor-fitting Type S030 and fastened with a bayonet catch, see **data sheet Type S030** ▶ for more information.

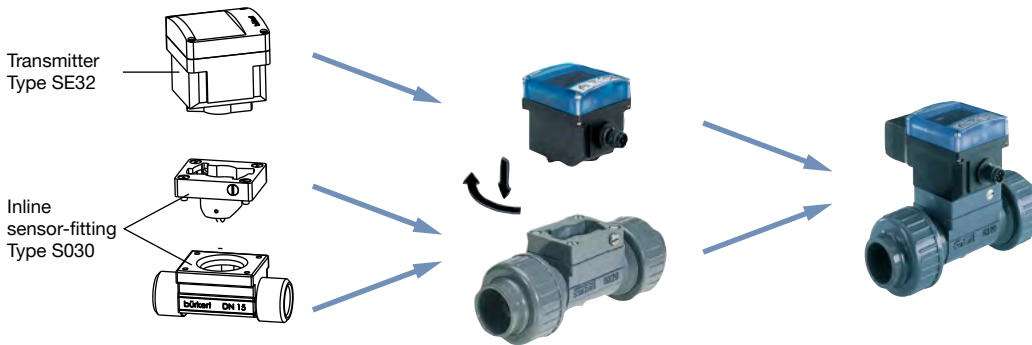

9. Networking and combination with other Bürkert products

Example:

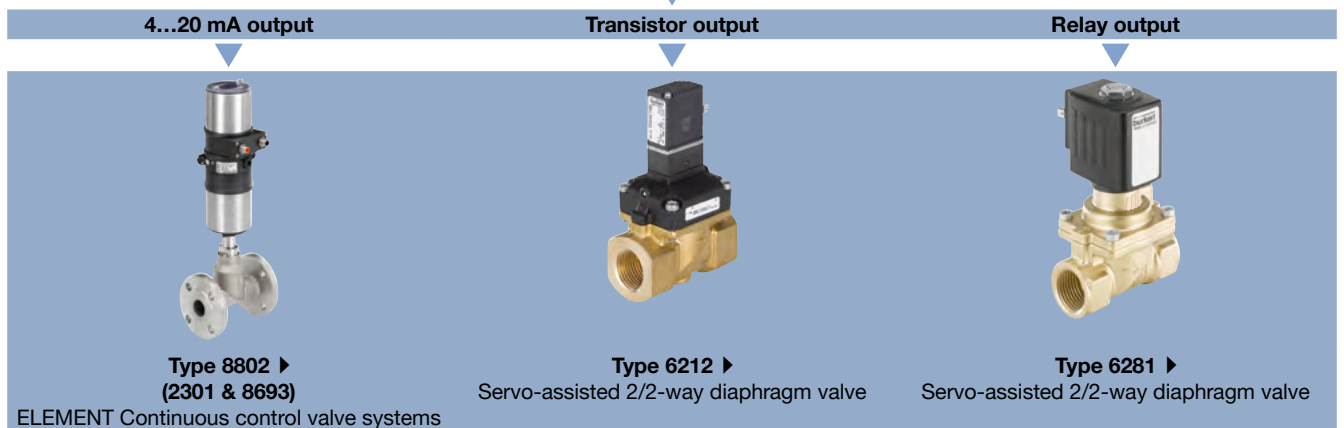

DTS 1000011084 EN Version: X Status: RL (released | freigegeben | validé) printed: 15.12.2023

10. Ordering information

10.1. Bürkert eShop



Bürkert eShop – Easy ordering and quick delivery

You want to find your desired Bürkert product or spare part quickly and order directly? Our online shop is available for you 24/7. Sign up and enjoy all the benefits.

[Order online now](#)

10.2. Recommendation regarding product selection

A complete flowmeter/threshold detector Type 8032 consists of a compact flow transmitter Type SE32 and a Bürkert Inline sensor-fitting Type S030.

See **data sheet Type S030** ▶ for more information.

Two different components must be ordered in order to select a complete device. The following information is required:

- **Article no.** of the desired compact Type SE32 flow transmitter (see chapter “10.4. Ordering chart” on page 14)
- **Article no.** of the selected Type S030 Inline sensor-fitting (see **data sheet Type S030** ▶)

10.3. Bürkert product filter



Bürkert product filter – Get quickly to the right product

You want to select products comfortably based on your technical requirements? Use the Bürkert product filter and find suitable articles for your application quickly and easily.

[Try out our product filter](#)





10.4. Ordering chart

Threshold detector Type SE32







Operating voltage	Output	UL approval	Electrical connection	Article no.	
12...36 V DC	1 x transistor NPN	No	Female cable plug DIN EN 175301-803	436474	
		UL Recognized		570475	
	1 x transistor PNP	No		434871	
		UL Recognized		570474	
	2 x transistors NPN/PNP	No		Free positionable 5-pin M12 male connector	436473
		UL Recognized			553431
Relay	No	Free positionable 5-pin M12 male connector and female cable plug DIN EN 175301-803	436475		
	UL Recognized		570476		

DTS 1000011084 EN Version: X Status: RL (released | freigegeben | valide) printed: 15.12.2023

Transmitter Type SE32

Operating voltage	Output	UL approval	Electrical connection	Article no.
12...36 V DC	4...20 mA + relay	No	8-pin M12 male connector and female cable plug DIN EN 175301-803	560547 
		UL Recognized		570488 
		No	Free positionable 5-pin M12 male connector and female cable plug DIN EN 175301-803	560402 
		UL Recognized		570486 
	4...20 mA	No	Free positionable 5-pin M12 male connector	560403 
				UL Recognized

10.5. Ordering chart accessories

Description	Article no.
Electrical connection	
M12 female connector with plastic threaded clamping ring, 5-pin, straight, to be wired	917116 
M12 female connector with moulded cable (shielded), 5-pin, straight, cable length: 2 m	438680 
M12 female connector with plastic threaded clamping ring, 8-pin, straight, to be wired	444799 
M12 female connector with moulded cable (shielded), 8-pin, straight, cable length: 2 m	444800 
Female cable plug, 4-pin (3 conductors + protective conductor), form A according to DIN EN 175301-803, with cable gland (Type 2518 )	572264 
Female cable plug 32 mm, 4-pin (3 conductors + protective conductor), form A according to DIN EN 175301-803, with NPT 1/2" reduction without cable gland (Type 2509 )	162673 