





Flowmeter with paddle wheel for continuous flow measurement

- Economic integration in pipe systems without any additional pipelines
- Optic or magnetic measuring principle
- Outputs: one analogue output 4...20 mA and/or one transistor output (frequency or switch)
- Outputs configurable (through interface on USB port with PC)

Product variants described in the data sheet may differ from the product presentation and description.

Can be combined with

- 
Type 8611 ▶
 eCONTROL - Universal controller
- 
Type 8025 ▶
 Insertion flowmeter/batch controller with paddle wheel and flow transmitter/remote batch controller
- 
Type 8619 ▶
 multiCELL - Multi-channel and multi-function transmitter/controller
- 
Type 2301 ▶
 Pneumatically operated 2 way Globe Control Valve

Type description

The paddle wheel flow meter is available in magnetic or optical variant.

The magnetic variant of the measuring instrument is especially designed for use with neutral, slightly aggressive, solid free liquids. The optical variant is exclusively intended for use with infrared transparent liquids.

The Type 8012 consists of a fitting (Type S012) and an electronic module (Type SE12) which are screwed together. The Bürkert designed fitting system ensures simple installation into all pipes from DN 06...DN 65. The Type 8012 can also be integrated in customer-specific block systems.

Depending on the electronics module variant, the Type 8012 is provided either with a pulse output or with a pulse output and a 4...20 mA current output.

The pulse output, which can be transmitted and processed by a Bürkert remote transmitter/controller, generates a configurable frequency proportional to the flow rate or can be used as a switch output.

Table of contents

1. General technical data	4
2. Approvals and conformities	6
2.1. General notes.....	6
2.2. Conformity	6
2.3. Standards.....	6
2.4. Pressure Equipment Directive (PED).....	6
Device used on a pipe	6
2.5. Lebensmittel und Getränke/Hygiene.....	6
3. Materials	6
3.1. Bürkert resistApp	6
3.2. Material specifications	7
4. Dimensions	7
4.1. Transmitter Type SE12	7
4.2. Transmitter Type SE12 mounted in a fitting Type S012	8
4.3. Metal fitting Type S012	8
Internal thread connection	8
External thread connection	8
4.4. Plastic sensor-fitting Type S012	9
True union connection with nut and solvent/fusion socket.....	9
External thread connection	9
5. Performance specifications	10
5.1. Pressure temperature diagram.....	10
6. Product installation	10
6.1. Installation notes	10
Flow measurement.....	10
6.2. Selection of the nominal diameter	12
6.3. Mounting options	13
Example of flow control systems with Type SE12 transmitter	13
7. Product operation	13
7.1. Measuring principle.....	13
7.2. Function modes	14
Variant with transistor output	14
Variant with transistor and current outputs.....	15
8. Product design and assembly	15
8.1. Product assembly	15
9. Product accessories	16
9.1. Seals for fitting	16
9.2. Configuration tool "TACTIC"	16
10. Networking and combination with other Bürkert products	17
11. Ordering information	17
11.1. Bürkert eShop.....	17

11.2.	Recommendation regarding product selection.....	17
	Basic flowmeter	17
	Variants of flowmeter	17
	Fitting variants Type S012.....	18
11.3.	Bürkert product filter.....	18
11.4.	Bürkert Product Enquiry Form	18
11.5.	Ordering chart.....	19
	Basic flowmeter	19
	Variants of transmitter Type SE12.....	20
11.6.	Ordering chart accessories.....	21

DTS 1000083708 EN Version: AD Status: RL (released | freigegeben | validé) printed: 25.04.2024

1. General technical data

Note:

If the device is mounted in a humid environment or outside, then the maximum voltage allowed is **35 V DC** instead of 36 V DC.

Product properties

Material

Make sure the device materials are compatible with the fluid you are using.

Further information can be found in chapter [“3.1. Bürkert resistApp” on page 6.](#)

Further information on the materials can be found in chapter [“3.2. Material specifications” on page 7.](#)

Non wetted parts

Housing	PPS
Screw	Stainless steel A4
Seal	EPDM
Fixed connector	PA
Cable gland	Cable gland in PA with 1 m connected cable in PVC (on request)

Wetted parts

Axis and bearing	Ceramics (Al ₂ O ₃)
Paddle wheel	PVDF (blue)
Holder	PVDF
Fitting body	Brass, stainless steel 1.4404/316L, PVC or PP
Seal	FKM (EPDM as option)
Compatibility	Electronic module Type SE12 compatible with Bürkert fitting Type S012 For the selection of the nominal diameter of the fittings, see chapter “6.2. Selection of the nominal diameter” on page 12.
Pipe diameter	DN 06...DN 50 (DN 65 on request)
Dimensions	Further information can be found in chapter “4. Dimensions” on page 7.
Measuring element	Optical, infra-red (or magnetic paddle wheel, on request)
Measuring range	<ul style="list-style-type: none"> Flow rate: 0.5...1000 l/min (0.13...265 gpm) Flow velocity: 0.3...10 m/s

Performance data

Measurement deviation	<ul style="list-style-type: none"> Teach-in¹⁾: ± 1 % of the measured value²⁾ at teach flow rate value Standard K factor: ± 2.5 % of the measured value²⁾
Linearity	± 0.5 % of full scale ²⁾
Repeatability	± 0.4 % of the measured value ²⁾
4...20 mA output uncertainty	± 0.16 mA

Electrical data

Operating voltage	12...36 V DC ± 10 %, filtered and regulated Connection to main supply: permanent, through external SELV (Safety Extra Low Voltage) and LPS (Limited Power Source) power supply
Power source (not supplied)	Limited power source according to UL/EN 62368-1 standards or limited energy circuit according to UL/EN 61010-1 paragraph 9.4
DC reverse polarity protection	Yes
Overvoltage protection	Yes
Current consumption	< 60 mA (at 12 V DC for current variant, without load)
Output	<ul style="list-style-type: none"> Transistor: <ul style="list-style-type: none"> NPN (default setting) or PNP (configurable on request), open collector 700 mA max. NPN-output: 0.2...36 V DC (default setting) PNP-output: power supply frequency or switching mode operating mode: window or hysteresis threshold protection against overvoltage, polarity reversals and short circuit Current: according to variant, configurable on request <ul style="list-style-type: none"> 4...20 mA (3 wire), sinking (default setting, configurable as sourcing on request) image of the flow velocity (default setting) loop impedance max.: 1125 Ω at 36 V DC, 650 Ω at 24 V DC, 140 Ω at 12 V DC
Voltage supply cable	Cross section of wires: max. 1.5 mm ²

Medium data

Fluid temperature	With Type S012 fitting in: <ul style="list-style-type: none"> • PVC: 0...+60 °C (+32...+140 °F) • PP: 0...+80 °C (+32...+176 °F) • stainless steel or brass: <ul style="list-style-type: none"> – -15...+100 °C (+5...+212 °F) (if T°ambient ≤ +45 °C) or – -15...+90 °C (+5...+194 °F) (if +45 °C ≤ T°ambient ≤ +60 °C)
Fluid pressure	With Type S012 fitting in: <ul style="list-style-type: none"> • plastic: max. PN 10 (145 PSI) • metal: max. PN 16 (232 PSI) Further information can be found in chapter “5.1. Pressure temperature diagram” on page 10.
Viscosity	Max. 300 cSt
Rate of solid particles	Max. 1 %
Maximum particle size	0.5 mm

Process/Pipe connection & communication

Pipe connection	With fitting in: <ul style="list-style-type: none"> • plastic: true union with nut and solvent socket, external thread (spigot on request) • metal: internal or external thread (weld ends, clamp or flange on request)
Electrical connection	Free positionable 5-pin M12 male connector or with 1 m cable via cable gland (on request)

Approvals and conformities

Directives

CE directive	Further information on the CE directive can be found in chapter “2.3. Standards” on page 6.
Pressure equipment directive	Complying with article 4, paragraph 1 of 2014/68/EU directive Further information on the pressure equipment directive can be found in chapter “2.4. Pressure Equipment Directive (PED)” on page 6.
Foods and beverages/Hygiene	On request: FDA-certificate (only for device with FKM or EPDM seal and stainless steel fitting)
Materials	On request: Certification of conformity for the surface quality DIN4762-DIN4768-ISO/4287/
Others	On request: <ul style="list-style-type: none"> • Inspection certificate 3.1 (according to EN-ISO 10204) • Test report 2.2 (according to EN-ISO 10204) • 3 points flow calibration certificate

Environment and installation

Ambient temperature	Operation and storage: -15...+60 °C (+5...+140 °F)
Relative air humidity	≤ 80 %, without condensation
Height above sea level	Max. 2000 m
Operating condition	Continuous
Equipment mobility	Fixed
Application range	Indoor and outdoor Protect the device against electromagnetic interference, ultraviolet rays and, when installed outdoors, against the effects of climatic conditions.
Degree of protection according to IEC/EN 60529	<ul style="list-style-type: none"> • IP67 with device wired and M12 female connector mounted and tightened • IP65 (with cable gland)
Installation category	Category I according to UL/EN 61010-1
Pollution degree	Degree 2 according to UL/EN 61010-1

1.) Special calibration method

2.) Under reference conditions i.e. measuring medium = water, ambient and water temperature = +20 °C (+68 °F), observing the minimum the minimum inlet and outlet sections and the appropriate inner diameter of the pipe.

2. Approvals and conformities

2.1. General notes

- The approvals and conformities listed below must be stated when making enquiries. This is the only way to ensure that the product complies with all required specifications.
- Not all available variants of the device can be supplied with the below mentioned approvals or conformities.

2.2. Conformity

In accordance with the Declaration of Conformity, the product is compliant with the EU Directives.

2.3. Standards

The applied standards which are used to demonstrate compliance with the EU Directives are listed in the EU-Type Examination Certificate and/or the EU Declaration of Conformity.

2.4. Pressure Equipment Directive (PED)

The device conforms to article 4, paragraph 1 of the Pressure Equipment Directive (PED) 2014/68/EU under the following conditions:

Device used on a pipe

Note:

- The data in the table is independent of the chemical compatibility of the material and the fluid.
- PS = maximum admissible pressure (in bar), DN = nominal diameter of the pipe

Type of fluid	Conditions
Fluid group 1, article 4, paragraph 1.c.i	$DN \leq 25$
Fluid group 2, article 4, paragraph 1.c.i	$DN \leq 32$ or $PS \cdot DN \leq 1000$
Fluid group 1, article 4, paragraph 1.c.ii	$DN \leq 25$ or $PS \cdot DN \leq 2000$
Fluid group 2, article 4, paragraph 1.c.ii	$DN \leq 200$ or $PS \leq 10$ or $PS \cdot DN \leq 5000$

2.5. Lebensmittel und Getränke/Hygiene

Conformity	Description
FDA	FDA – Code of Federal Regulations Only devices with FKM or EPDM seal and stainless steel fitting are compliant with the Code of Federal Regulations published by the FDA (Food and Drug Administration, USA) according to the manufacturer’s declaration.

3. Materials

3.1. Bürkert resistApp

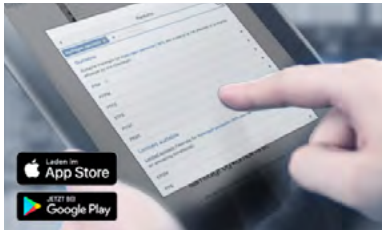

Bürkert resistApp – Chemical resistance chart

You want to ensure the reliability and durability of the materials in your individual application case? Verify your combination of media and materials on our website or in our resistApp.

[Start chemical resistance check](#)

3.2. Material specifications

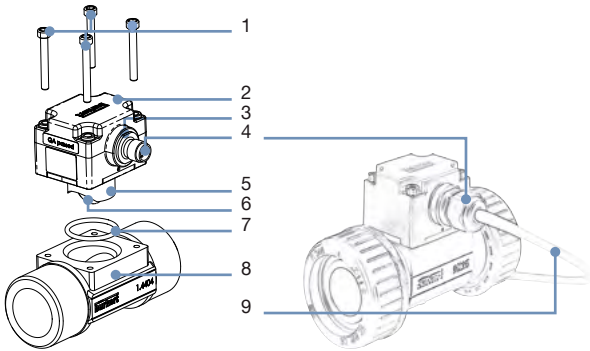

No.	Element	Material
1	Screws	Stainless steel A4
2	Housing	PPS
3	Seal	EPDM
4	M12 male connector or cable gland	PA
5	Axis and bearing	Ceramics (Al_2O_3)
6	Paddle wheel and holder	PVDF
7	Seal	FKM (EPDM as option)
8	Fitting	Brass, stainless steel 1.4404/316L, PVC or PP
9	Cable	PVC

4. Dimensions

4.1. Transmitter Type SE12

Note:

- Dimensions in mm, unless otherwise stated
- Variant with cable on request

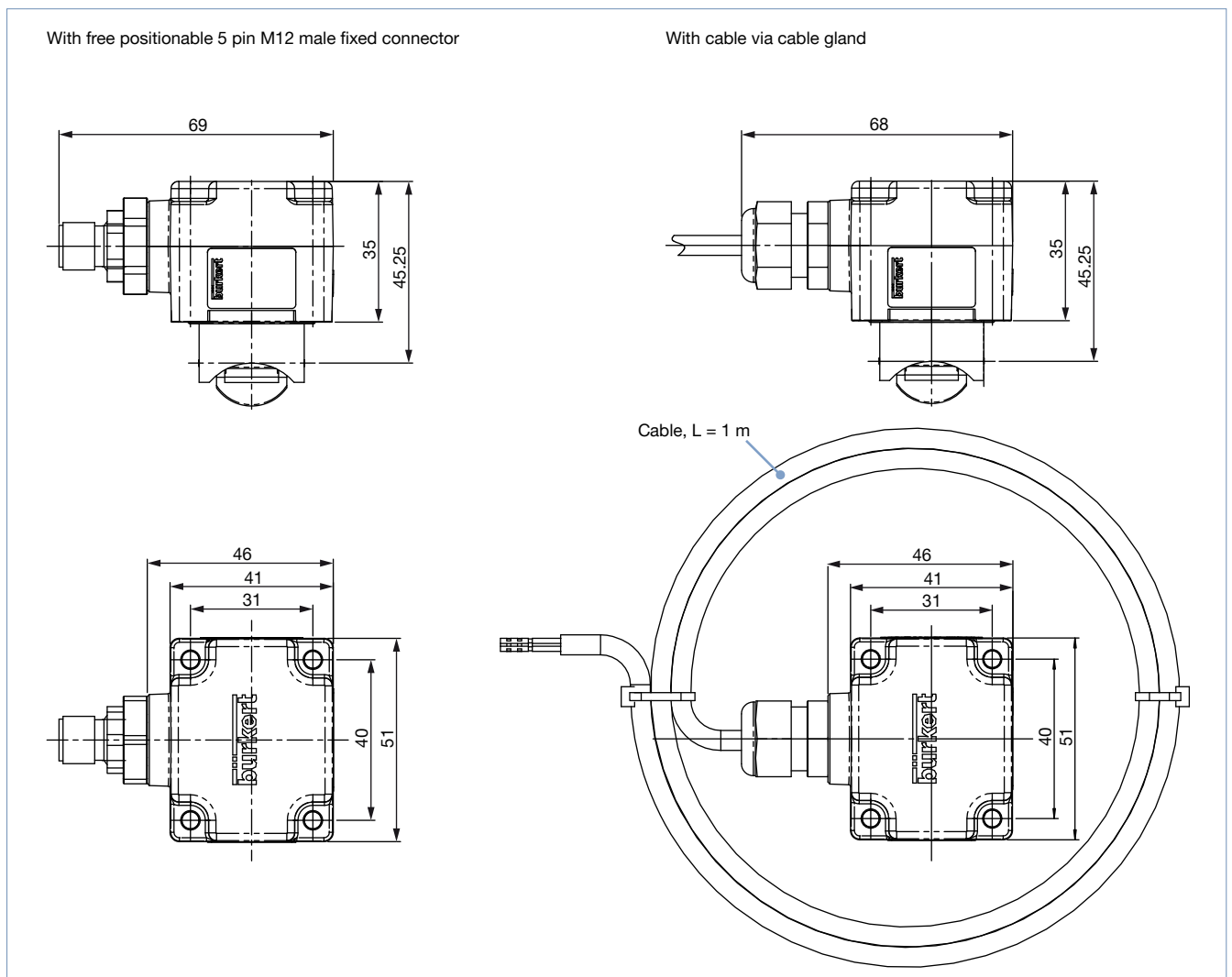

DTS 1000083708 EN Version: AD Status: RL (released | freigegeben | valide) printed: 25.04.2024

4.2. Transmitter Type SE12 mounted in a fitting Type S012

Note:

Dimensions in mm, unless otherwise stated

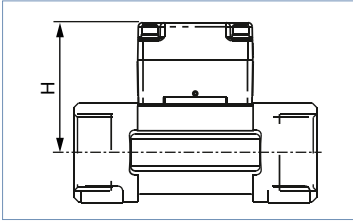

DN	H
06	52.5
08	52.5
15	57.5
20	55.0
25	55.2
32	58.8
40	62.6
50	68.7

4.3. Metal fitting Type S012

Internal thread connection

Note:

Dimensions in mm, unless otherwise stated

G, NPT or Rc in stainless steel (316L - 1.4404) or brass (CuZn₃₉Pb₂)

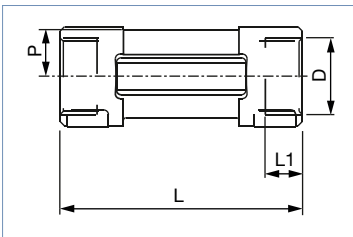

DN	P	L	L1	D
				[inch]
15	22.5	84.0	16.0	G ½
				NPT ½
				Rc ½
20	20.0	94.0	17.0	G ¾
				NPT ¾
				Rc ¾
25	20.2	104.0	23.5	G 1
				NPT 1
				Rc 1
32	23.8	119.0	23.5	G 1 ¼
				NPT 1 ¼
				Rc 1 ¼
40	27.6	129.0	23.5	G 1 ½
				NPT 1 ½
				Rc 1 ½
50	33.7	148.5	27.5	G 2
				NPT 2
				Rc 2

External thread connection

Note:

Dimensions in mm, unless otherwise stated

G, NPT or Rc in stainless steel (316L - 1.4404), brass (CuZn₃₉Pb₂)

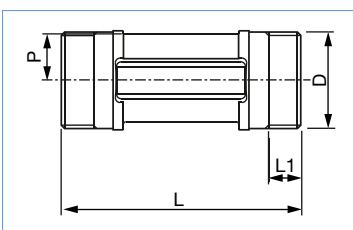

DN	P	L	L1	D	
				[Inch]	[mm]
06	17.5	90.0	14.0	G ½	-
08	17.5	90.0	14.0	G, NPT, RC ½	M16x1.5
according to fitting variant					

DTS 1000083708 EN Version: AD Status: RL (released | freigegeben | valide) printed: 25.04.2024

4.4. Plastic sensor-fitting Type S012

True union connection with nut and solvent/fusion socket

Note:

Dimensions in mm, unless otherwise stated

DIN 8063, ASTM D 1785/76 or JIS K in PVC

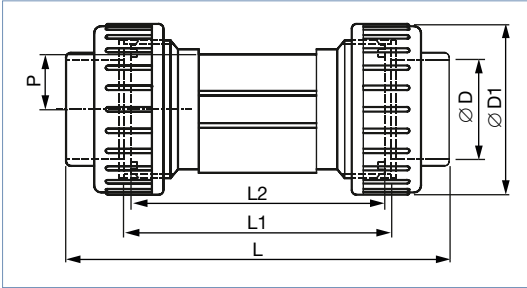

DN	P	Stand-ard	L	L1	L2	ØD	ØD1
15	22.5	DIN/ISO	128.0	96	90	20.00	43
		ASTM	130.0			21.30	
		JIS	129.0			18.40	
20	20.0	DIN/ISO	144.0	106	100	25.00	53
		ASTM	145.6			26.70	
		JIS	145.0			26.45	
25	20.2	DIN/ISO	160.0	116	110	32.00	60
		ASTM	161.4			33.40	
		JIS	161.0			32.55	
32	23.8	DIN/ISO	168.0	116	110	40.00	74
		ASTM	170.0			42.20	
		JIS	169.0			38.60	
40	27.6	DIN/ISO	188.0	127	120	50.00	83
		ASTM	190.2			48.30	
		JIS	190.0			48.70	
50	33.7	DIN/ISO	212.0	136	130	63.00	103
		ASTM	213.6			60.30	
		JIS	213.0			60.80	

External thread connection

Note:

Dimensions in mm, unless otherwise stated

G, NPT or Rc in PVC

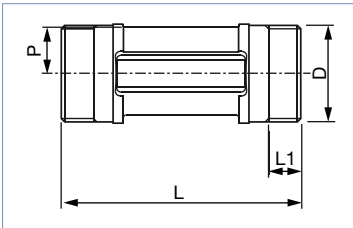

DN	P	L	L1	D	
				[Inch]	[mm]
06	17.5	90.0	14.0	G ½	-
08	17.5	90.0	14.0	G, NPT, RC ½ according to fitting variant	M16x1.5

5. Performance specifications

5.1. Pressure temperature diagram

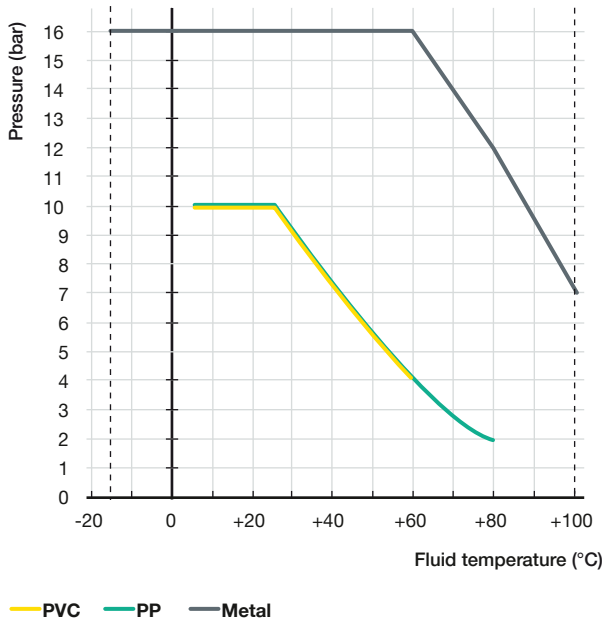

6. Product installation

6.1. Installation notes

Flow measurement

Note:

The device is not suitable for use in gaseous media and steam.

Minimum straight distances upstream and downstream of the sensor must be observed. These stabilizing distances depend on the pipe's design. Increasing these distances or installing a flow conditioner may be necessary to obtain the best accuracy. For more information, refer to EN ISO 5167-1.

EN ISO 5167-1 specifies the straight inlet and outlet distances that must be complied with when installing fittings in pipe lines in order to achieve calm flow conditions. The most commonly used elements that could lead to turbulence in the flow are shown in the following. The related minimum inlet and outlet distances that ensure a calm flow are also specified.

Make sure that the measuring conditions at the point of measurement are calm and problem-free.

DN = Orifice

Fluid direction ⇨

Regulating valve¹⁾

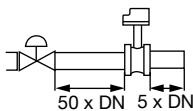

2 x 90° elbow joint

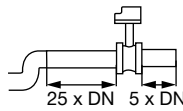

Expansion²⁾

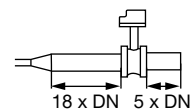

2 x 90° elbow joint
3 dimensional

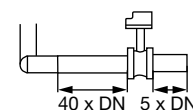

90° elbow joint
or T-piece

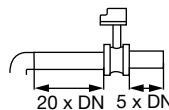

Reduction

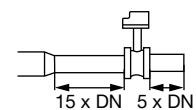

1.) If the valve cannot be mounted after the measuring device, the minimal distances have to be respected.

2.) If an expansion cannot be avoided, the minimal distances have to be respected.

Please note minimum flow velocity

The device can be installed in either horizontal or vertical pipes, but following additional conditions should be respected:

- The device has to be installed so that the paddle wheel axis is horizontal.
- The pipe always has to be filled with fluid at all times near the device.
- The pipe design must be such that no air bubbles or cavitation can form within the medium near the device at any time.

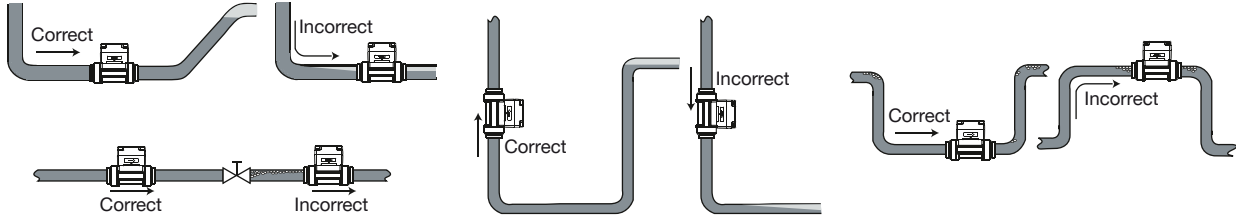

Pressure and temperature ratings must be respected according to the selected fitting material. The suitable pipe size is selected using the diagram in the chapter [“6.2. Selection of the nominal diameter”](#) on page 12.

6.2. Selection of the nominal diameter

The following graph is used to determine the appropriate DN of the pipe and fitting for the application, according to the fluid velocity and the flow rate. On the chart, the intersection of flow velocity and flow rate gives the appropriate diameter.

Note:

For the sensor fittings listed below, the corresponding nominal size in the bracket must be used:

- External threads according to SMS 1145
- Weld ends according to SMS 3008, BS4825-1/ASME BPE/DIN 11866 series C or DIN 11850 series 2/DIN 11866 series A/ DIN EN 10357 series A
- Clamp according to SMS 3017, BS 4825-3/ASME BPE or DIN 32676 series A

For all other sensor fittings, the corresponding nominal diameter without bracket applies.

Example 1:

- Nominal flow: 10 m³/h
 - Optimal flow rate: 2...3 m/s
- Result: Select a pipe size of DN 40

Example 2 with external threads according to SMS 1145:

- Nominal flow: 10 m³/h
 - Optimal flow rate: 2...3 m/s
- Result: Select a pipe size of DN 50

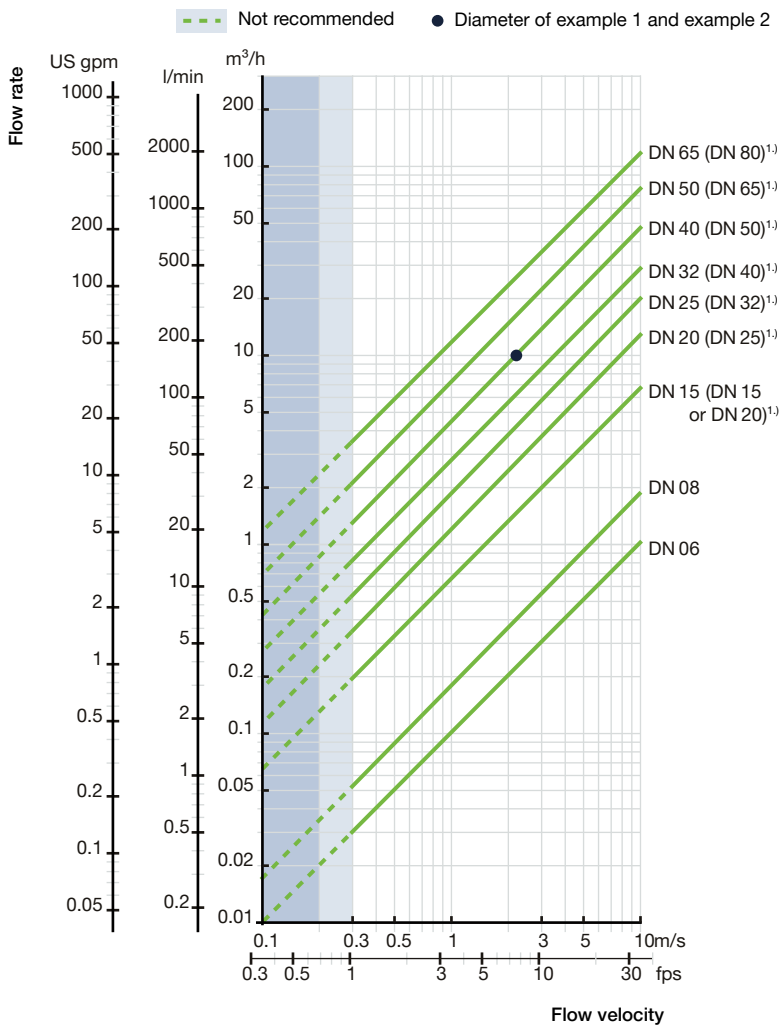





1.) See note at the beginning of this chapter.

6.3. Mounting options

The modular concept of the Type SE12 electronic module allows fully customized, pre-mounted and tested solutions to completely meet application needs. The electronic module is designed for being mounted in a system block, combined with other Bürkert products. This allows cost reduction and compact design for customized solutions.

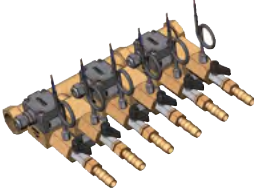
Contact your local Bürkert sales centre to have individual counselling and engineering support in order to find the best solution corresponding to your application.

Example of flow control systems with Type SE12 transmitter

<p>Assembly 1</p> <p>Cooling of moulding tools in plastic injection machines Flow (Type 8012) + temperature + manual On/Off valve</p> 	<p>Assembly 2</p> <p>Filter monitoring in waste water treatment Flow (Type 8012) + pressure (Type 8316)</p> 
<p>Assembly 3</p> <p>Cooling of welding robot in automotive industry Flow (Type 8012) + pilot valve (Type 6014) + On/Off diaphragm valve (Type 0263)</p> 	<p>Assembly 4</p> <p>Flow regulation in Ro water treatment skid Process valve (Type 2712 + Type 8692) + Flow (Type 8012)</p> 

7. Product operation

7.1. Measuring principle

The Type SE12 electronic module is equipped with two LED indicators, visible, due to transparency nature of material, under the male connector (standard) or on the side opposite the male connector (on request).

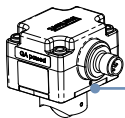

Location of the LEDs

When the power is turned on, the green LED lights up and flashes proportionally to the paddle wheel rotation frequency. The lighting up of the red indicator LED indicates a malfunction of the device. When liquid flows into the pipe, the paddle wheel is rotated. The non-wetted permanent magnets inserted in the paddle wheel generate a measuring signal whose frequency is proportional to the flow velocity. With the optical method, the same procedure is used, but the light beam is interrupted.

Two electronic module variants allow the following outputs:

- With one pulse output (either NPN or PNP transistor output, configurable).
An external power supply of 12...36 V DC is required. This pulse output generates a signal whose frequency is proportional to the flow velocity. It is designed for connection to any system with open collector NPN or PNP frequency input.
- With one 4...20 mA current output and one pulse output (either NPN or PNP transistor output, configurable).
An external power supply of 12...36 V DC is required. The 4...20 mA output delivers a current whose value is the image of the flow velocity.

The output signal is provided via a free positionable male 5-pin M12 male connector (or a cable gland with 1 m length cable on request).

7.2. Function modes

Variant with transistor output

Note:

Valid for the Type 8012 with optical principle (standard) or magnetic principle (on request)

- Transistor output: NPN operation (standard) or PNP operation (on request)
- With one configured transistor output mode (four possibilities):
 - raw frequency (standard) – (two pulses per paddle wheel rotation)

Raw frequency

Pulse length:
 - 50 % ON
 - 50 % OFF

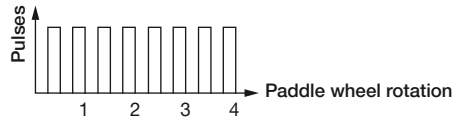

- proportional frequency (on request) – (e.g. five pulses per litre)

Proportional frequency

Pulse length:
 - 50 % ON
 - 50 % OFF

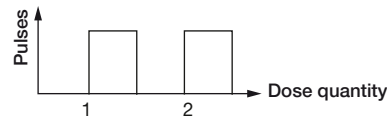

- two switching modes for the output, either hysteresis or window, inverted or not, depending on the kind of the transistor output. Configurable delay before switching

Hysteresis mode

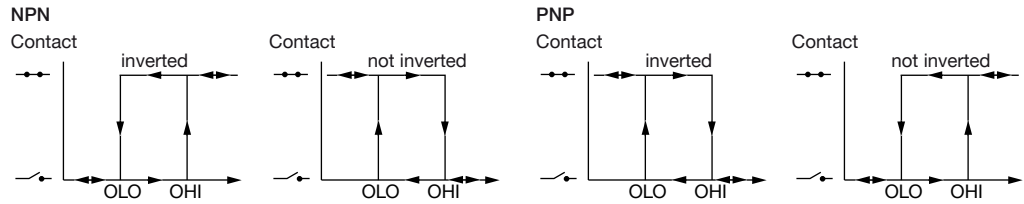

Window mode

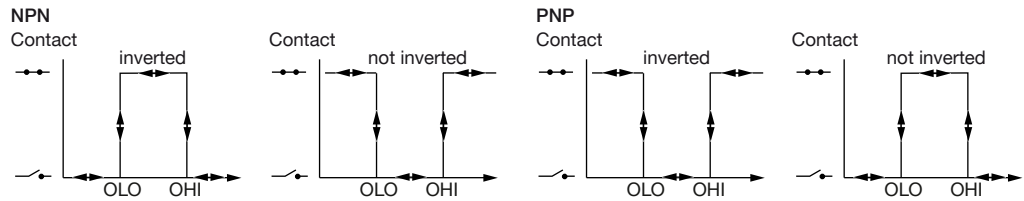

- Detection of flow direction – only with optical principle

Variant with transistor and current outputs

Note:

Valid for the Type 8012 with optical principle (standard) or magnetic principle (on request)

- Transistor output:
 - see **“Variant with transistor output” on page 14**
- Current output:
 - with sinking wiring (standard) or sourcing wiring (on request)
 - Type 8012 with configurable current output:
 - 4...20 mA current corresponding to paddle wheel frequency (0...250 Hz) – (standard)

Paddle wheel frequency

$Q = f/K$

Q: flow rate [l/s]

f: frequency [Hz]

K: K-factor [pulse/litre]

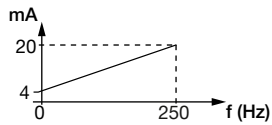

4...20 mA current corresponding to a flow range – (on request)

Flow range

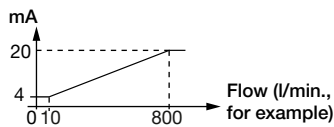

- Adjustable damping of current output signal
- Generation of an alarm current (22 mA), when fluid circulation is opposite to the direction indicated by the arrow on the side of the housing (only variants with optical principle) or when full scale has been exceeded (variants with optical or magnetic principle).

8. Product design and assembly

8.1. Product assembly

Note:

- The device Type 8012 is made up of a fitting Type S012 and a transmitter Type SE12 equipped with a paddle wheel sensor.
- The drawing shows the assembly of a Type S012 fitting with an internal thread process connection and a Type SE12 transmitter (Type S012 + Type SE12 = Type 8012). This also applies to all variants of the process connection and the transmitter.

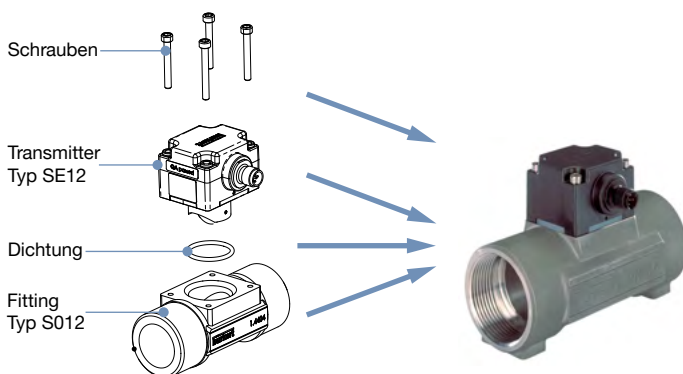

DTS 1000083708 EN Version: AD Status: RL (released | freigegeben | valide) printed: 25.04.2024

9. Product accessories

9.1. Seals for fitting

Note:

Since March 2012, the Type S012 fittings in DN 15 and DN 20 have been available in 2 variants with different K factors. Further information can be found in the user manual in the K factor chapter, see **Type 8012** ▶.

The 2nd variant is identified by the “v2” marking. This “v2” marking can be found:

- on the bottom of the DN 15 or DN 20 fitting in plastic

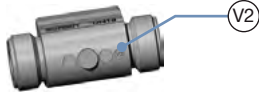

- on the side of the DN 15 or DN 20 fitting in metal

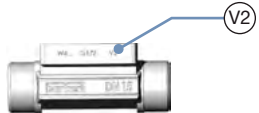

Accessory	No.	Description
	1	O-ring set for metal sensor-fitting
	2	O-ring set for plastic sensor-fitting (O-Ring for process connection and seal ^{1.)} for sensor holder)

1.) Depends on sensor armature variant: flat seal to use for armature with groove (previous variant, no longer available), O-ring seal to use for armature with chamfer (variant “v2”)

9.2. Configuration tool “TACTIC”

Note:

To configure a device with more specific parameters than the basic settings, you need:

- the configuration tool (to be ordered separately, see chapter “11.6. Ordering chart accessories” on page 21) and
- the configuration software (available on the product website under “Software”, see **Type 8012** ▶).

Accessories	No.	Description
	1	“TACTIC” USB cable, 1 m length
	2	“TACTIC” electronic housing
	3	“TACTIC” cable with M12 female connector
	4	Flowmeter Type 8012
	5	Type 8012 configuration software

DTS 1000083708 EN Version: AD Status: RL (released | freigegeben | valide) printed: 25.04.2024

10. Networking and combination with other Bürkert products

Example:

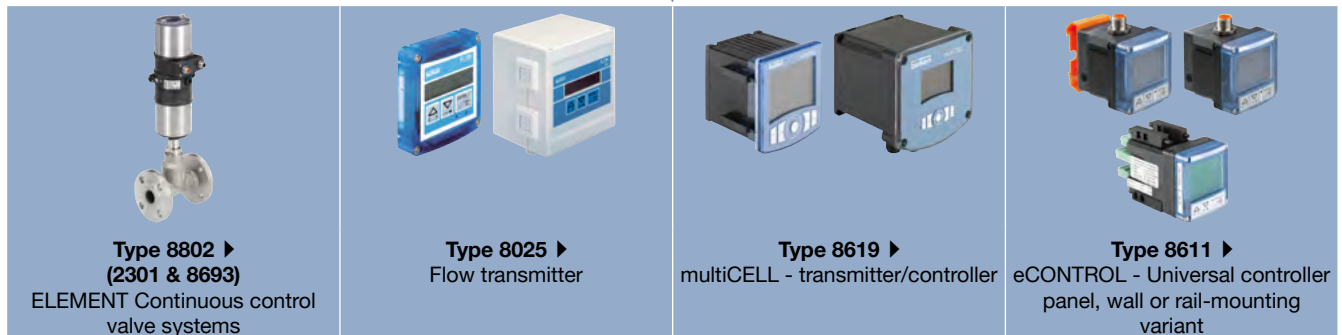

11. Ordering information

11.1. Bürkert eShop



Bürkert eShop – Easy ordering and quick delivery

You want to find your desired Bürkert product or spare part quickly and order directly? Our online shop is available for you 24/7. Sign up and enjoy all the benefits.

[Order online now](#)

11.2. Recommendation regarding product selection

Basic flowmeter

The proposed Type 8012 basic flowmeter is a device with optical measuring principle, powered by 12...36 V DC through a 5-pin M12 male connector. Further information can be found in chapter [“11.5. Ordering chart” on page 19](#).

Variants of flowmeter

A complete Type 8012 flowmeter consists of:

- A Type SE12 electronic module with many variants:
 - With either optical or magnetic measuring principle
 - With only pulse output or with both pulse and 4...20 mA current outputs
 - Configured as standard (see [“11.5. Ordering chart” on page 19](#), Type SE12) or customized (see [“11.4. Bürkert Product Enquiry Form” on page 18](#))
 - Electrical connection carried out through a 5-pin M12 male connector or a 1 m cable
- A Type S012 fitting, available in different materials and with different process connection types. The fitting provides many installation options of the electronic module into all pipes from DN 06...DN 65 (see [“Fitting variants Type S012” on page 18](#) or [“11.4. Bürkert Product Enquiry Form” on page 18](#))
- Screws and O-ring (see [“11.6. Ordering chart accessories” on page 21](#))

Fitting variants Type S012

Note:

- The Type S012 fitting is not available as a separate part, so it can not be ordered separately.
- Fittings in PVDF are not available.
- Order the combination of transmitter and fitting (including associated Type 8012 configuration) from your Bürkert sales office.

Pipe connection	Material	Available fittings								
		DN 06	DN 08	DN 15	DN 20	DN 25	DN 32	DN 40	DN 50	DN 65
Internal thread	Brass, stainless steel	–	–	Yes	Yes	Yes	Yes	Yes	Yes	–
External thread	Brass, stainless steel, PVC, PP	Yes	Yes	Yes	Yes	Yes	Yes	Yes	Yes	–
	Stainless steel acc. to SMS 1145	–	–	–	–	Yes	–	Yes	Yes	–
Weld ends	Stainless steel	–	Yes	Yes	Yes	Yes	Yes	Yes	Yes	Yes
Clamp	Stainless steel	–	Yes	Yes	Yes	Yes	Yes	Yes	Yes	Yes
Flange	Stainless steel	–	–	Yes	Yes	Yes	Yes	Yes	Yes	–
True union	PVC	–	Yes	Yes	Yes	Yes	Yes	Yes	Yes	–
	PP	–	–	Yes	Yes	Yes	Yes	Yes	Yes	–
Spigot	PVC, PP	–	–	Yes	Yes	Yes	Yes	Yes	Yes	–

11.3. Bürkert product filter



Bürkert product filter – Get quickly to the right product

You want to select products comfortably based on your technical requirements? Use the Bürkert product filter and find suitable articles for your application quickly and easily.

[Try out our product filter](#)

11.4. Bürkert Product Enquiry Form

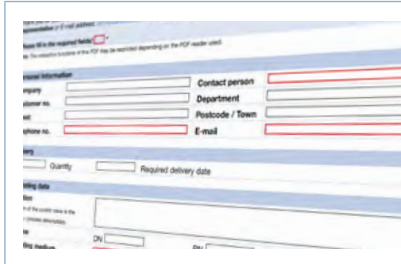

Bürkert Product Enquiry Form – Your enquiry quickly and compactly

Would you like to make a specific product enquiry based on your technical requirements? Use our Product Enquiry Form for this purpose. There you will find all the relevant information for your Bürkert contact. This will enable us to provide you with the best possible advice.

[Fill out the form now](#)

DTS 1000083708 EN Version: AD Status: RL (released | freigegeben | valide) printed: 25.04.2024

11.5. Ordering chart

Basic flowmeter

Note:

Since March 2012, the Type S012 fittings in DN 15 and DN 20 have been available in 2 variants with different K factors. Further information can be found in chapter "9.1. Seals for fitting" on page 16 or user manual in the K factor chapter, see **Type 8012** ▶.

The following variants have an optical measuring principle, a 12...36 V DC operating voltage and a 5-pin M12 male connector.

Standard	Output ^{1.)}	Article no.								
		DN 06 1/4"	DN 06 1/2"	DN 08 1/2"	DN 15	DN 20	DN 25	DN 32	DN 40	DN 50
Brass body, FKM seal - Fluid temperature max. 100 °C, PN 16										
Internal thread pipe connection										
G	Pulse	-	-	-	556003	556004	556005	556006	556007	556008
	Pulse + 4...20 mA	-	-	-	556012	556013	556014	556015	556016	556017
NPT	Pulse	-	-	-	556018	556019	556020	556021	556022	556023
	Pulse + 4...20 mA	-	-	-	556024	556025	556026	556027	556028	556029
Rc	Pulse	-	-	-	556030	556031	556032	556033	556034	556035
	Pulse + 4...20 mA	-	-	-	556036	556037	556038	556039	556040	556041
External thread pipe connection										
G	Pulse	556000	556001	556002	-	-	-	-	-	-
	Pulse + 4...20 mA	556009	556010	556011	-	-	-	-	-	-
Stainless steel body, FKM seal - Fluid temperature max. 100 °C, PN 16										
Internal thread pipe connection										
G	Pulse	-	-	-	556045	556046	556047	556048	556049	556050
	Pulse + 4...20 mA	-	-	-	556054	556055	556056	556057	556058	556059
NPT	Pulse	-	-	-	556061	556062	556063	556064	556065	556066
	Pulse + 4...20 mA	-	-	-	556068	556069	556070	556071	556072	556073
Rc	Pulse	-	-	-	556074	556075	556076	556077	556078	556079
	Pulse + 4...20 mA	-	-	-	556080	556081	556082	556083	556084	556085
External thread pipe connection										
G	Pulse	556042	556043	556044	-	-	-	-	-	-
	Pulse + 4...20 mA	556051	556052	556053	-	-	-	-	-	-
NPT	Pulse	-	-	556060	-	-	-	-	-	-
	Pulse + 4...20 mA	-	-	556067	-	-	-	-	-	-
PVC body, FKM seal - Fluid temperature max. 60 °C, PN 10										
True union pipe connection with nut and solvent socket										
DIN 8063	Pulse	-	-	-	556088	556089	556090	556091	556092	556093
	Pulse + 4...20 mA	-	-	-	556094	556095	556096	556097	556098	556099
ASTM	Pulse	-	-	-	556100	556101	556102	556103	556104	556105
	Pulse + 4...20 mA	-	-	-	556106	556107	556108	556109	556110	556111
JIS	Pulse	-	-	-	556112	556113	556114	556115	556116	556117
	Pulse + 4...20 mA	-	-	-	556118	556119	556120	556121	556122	556123
External thread pipe connection										
G	Pulse	-	556086	556124	-	-	-	-	-	-
	Pulse + 4...20 mA	-	556087	556125	-	-	-	-	-	-

1.) Factory setting:

- NPN pulse (raw frequency)
- NPN pulse (raw frequency) + 4...20 mA (sinking mode, 0...250 Hz)
- other configurations are available on request.

DTS 1000083708 EN Version: AD Status: RL (released | freigegeben | valide) printed: 25.04.2024

Further variants on request	
Process connection <ul style="list-style-type: none"> External thread SMS 1145 Weld ends SMS 3008, BS 4825-1/ASME BPE/DIN 11866 series C or DIN 11850 series 2/DIN 11866 series A/ DIN EN 10357 series A Clamp DIN 32676 series B, SMS 3017, BS 4825-3/ASME BPE or DIN 32676 series A Flange EN1092-1/B1/PN 16, ANSI B16-5 or JIS 10K True union ISO 10931 Spigot ISO 10931 	Material Fitting: PP
	Electrical connection With 1 m cable via cable gland
	Additional Magnetic measuring principle

Variants of transmitter Type SE12

Note:

- Order the combination of transmitter and fitting (including associated Type 8012 configuration) from your Bürkert sales office.
- The following charts show the different variants of the Type SE12 transmitter, which can be combined with a Type S012 fitting.

Description	Operating voltage	Pipe connection	Output ^{1.)}	Electrical connection	Article no.
Magnetic measuring principle	12...36 V DC	DN 06, DN 08, DN 15 v2 and DN 20 v2	Frequency with pulse NPN	Free positionable 5-pin M12 male connector	557054
			Frequency with pulse NPN + 4...20 mA		557058
			Frequency with pulse NPN	With 1 m cable via cable gland	557056
			Frequency with pulse NPN + 4...20 mA		557060
		DN 15...DN 50 (except DN 15 v2 and DN 20 v2)	Frequency with pulse NPN	Free positionable 5-pin M12 male connector	557053
			Frequency with pulse NPN + 4...20 mA		557057
			Frequency with pulse NPN	With 1 m cable via cable gland	557055
			Frequency with pulse NPN + 4...20 mA		557059
Optical measuring principle	12...36 V DC	DN 06, DN 08, DN 15 v2 and DN 20 v2	Frequency with pulse NPN	Free positionable 5-pin M12 male connector	557062
			Frequency with pulse NPN + 4...20 mA		557066
			Frequency with pulse NPN	With 1 m cable via cable gland	557064
			Frequency with pulse NPN + 4...20 mA		557068
		DN 15...DN 50 (except DN 15 v2 and DN 20 v2)	Frequency with pulse NPN	Free positionable 5-pin M12 male connector	557061
			Frequency with pulse NPN + 4...20 mA		557065
			Frequency with pulse NPN	With 1 m cable via cable gland	557063
			Frequency with pulse NPN + 4...20 mA		557067





















1.) Factory setting:

- pulse NPN (raw frequency)
- pulse NPN (raw frequency) + 4...20 mA (sinking mode, 0...250 Hz)
- other configurations on request

For further variants, see chapter "11.4. Bürkert Product Enquiry Form" on page 18.

DTS 1000083708 EN Version: AD Status: RL (released | freigegeben | valide) printed: 25.04.2024

11.6. Ordering chart accessories

Description	Article no.
Screws set	
4 short screws (M4 x 35, stainless steel A4) + 4 long screws (M4 x 60, stainless steel A4)	555775 
O-ring set	
FKM O-ring for metal fitting, DN 06...DN 65	426340 
EPDM O-ring for metal fitting, DN 06...DN 65	426341 
FKM O-ring for plastic fitting, DN 08	448679 
FKM O-ring for plastic fitting, DN 15	431555 
FKM O-ring for plastic fitting, DN 20	431556 
FKM O-ring for plastic fitting, DN 25	431557 
FKM O-ring for plastic fitting, DN 32	431558 
FKM O-ring for plastic fitting, DN 40	431559 
FKM O-ring for plastic fitting, DN 50	431560 
EPDM O-ring for plastic fitting, DN 08	448680 
EPDM O-ring for plastic fitting, DN 15	431561 
EPDM O-ring for plastic fitting, DN 20	431562 
EPDM O-ring for plastic fitting, DN 25	431563 
EPDM O-ring for plastic fitting, DN 32	431564 
EPDM O-ring for plastic fitting, DN 40	431565 
EPDM O-ring for plastic fitting, DN 50	431566 
Electrical connection	
M12 female connector with plastic threaded clamping ring, 5-pin, straight, to be wired	917116 
M12 female connector with moulded cable (shielded), 5-pin, straight, cable length: 2 m	438680 
Configuration accessory	
Configuration tool "TACTIC" (1 "TACTIC" interface + USB cable with USB plug type A to USB plug type B, cable length 1 m + "TACTIC" cable with M12 female connector, 5-pin, straight, cable length 1 m)	556500 
Cable set for connection between Type 8012 flowmeter, "TACTIC" interface and computer (USB cable with USB plug type A to USB plug type B, cable length 1 m + "TACTIC" cable with M12 female connector, 5-pin, straight, cable length 1 m)	556160 